











ParaPicker Industrial Robots



Typical Applications

	Palettizing
	Packaging
	Grouping
	Sorting
	Glueing
	Varnishing
	Mounting
	Controlling
	Feeding
	Tooling

- Three axis parallel kinematic robot
- High dynamic driven by linear direct drives
- Rotation axis optional
- Excellent for high dynamic applications
- Freely positionable in work space



ParaPicker Industrial Robots Overview

ParaPicker are three axis parallelkinematic robots with three actuator arms. The actuators consist of *HighDynamic* linear guides which are driven by linear direct drives. Due to the use of standard guides and standard drives, the robots have a very high performance at extreme low cost.

ParaPicker robots are characterized by highest flexibility and high dynamic performance at extreme low cost.

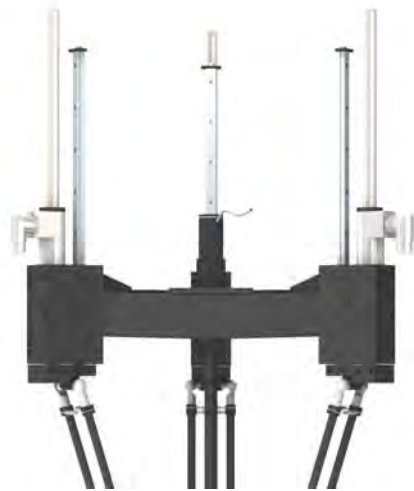

ParaPicker actuators with linear direct drives







The working platform has a very low mass and high stiffness. Optional a high dynamic rotating axis is available. Pneumatic and electric grippers can be adapted. Energy supply of such units can be realized by optional feeding units in the actuators and the carbon fiber tubes.



ParaPicker working platform with rotating axis

ParaPicker robots include a programmable control, which is able to realize high dynamic movements in space. The standard software includes different motion profiles. Therefore most motion applications are solvable.

Integrated Motion Profiles

-  **Pick**
-  **Circular segment**
-  **Straight line**
-  **Curve in space**
-  **Spiral**
-  **Helix**
-  **Track**

ParaPicker data overview	max. working area [mm]	max. stroke Z-direction [mm]	max. force Z-direction [N]	max. force X- and Y-direction [N]	typ. speed [m/s]	typ. acceleration [m/s ²]	typ. load [kg]	protection
PP03-23								Coming soon!
PP03-37	Ø600	280	200	200	3,0	50	1,0	IP20
PP03-48								Coming!

Technical changes on demand!

ParaPicker Standard Motion Profiles

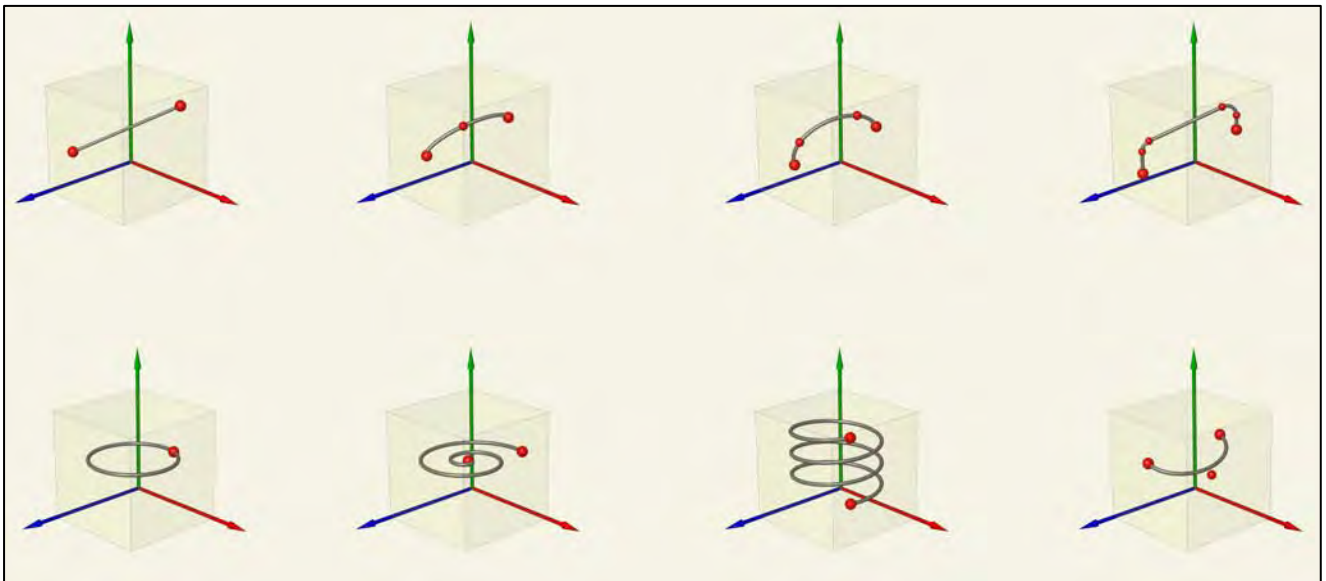

ParaPicker Contact



**JUNG ANTRIEBSTECHNIK U.
AUTOMATION GMBH**
Felsweg 18
D-35435 Wettenberg
Germany
Phone: +49-(0)641-48017-0
Fax: +49-(0)641-48017-15
eMail: ja2@ja2-gmbh.de
Web: www.ja2-gmbh.de
www.parapicker.de

Distributed by:



ParaPicker is a trade mark!
Technical changes on demand!
Rev.: 20.01.2011 / js020111

Distributors for Australia & New Zealand

MOTION TECHNOLOGIES PTY LTD

24/22-30 Northumberland Road
Caringbah NSW 2229 Australia
Phone: (02) 9524 4782
Fax: (02) 9525 3878

sales@motiontech.com.au
www.motiontech.com.au

